

Ordering code

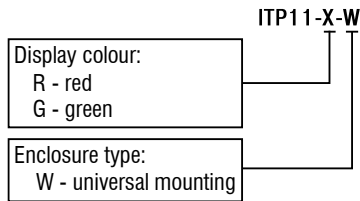

Functions

The ITP11 is a universally applicable digital display unit. It is designed to be connected to any device with a 4-20 mA output (current loop).

The device has the following functions:

- Process value is displayed in accordance with the set limit values and the decimal point position
- Display range -999...9999
- Filter for damping the signal fluctuations with an adjustable time constant
- Switching between linear and square root (for special transmitters)
- Displaying error message when exceeding the measuring limit
- Protection against unauthorized access

Specifications

Supply current	from current loop
Voltage drop	≤ 10 V *
Input signal	4-20 mA
Measuring range	3.8...22.5 mA
Accuracy	0.2% + 1 digit
Sampling rate (without damping)	1 reading / s
Ambient temperature	-40...+80 °C
Application class according to IEC 61140	III
IP Code	IP65
Dimensions (without carrier and cable gland)	70 x 50 x 28 mm
Weight	approx. 150 g
Mounting	DIN rail, wall, tube
Cable clamping range	∅ 3...6 mm

► **NOTICE**

* **Power supply must be provided not only for ITP11, but also for a sensor. The device voltage drop of 10 V has to be taken into account.**

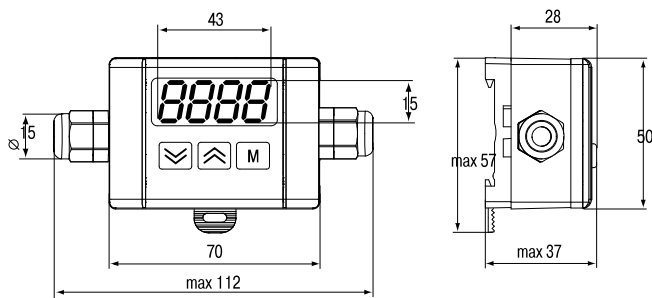

Fig. 1

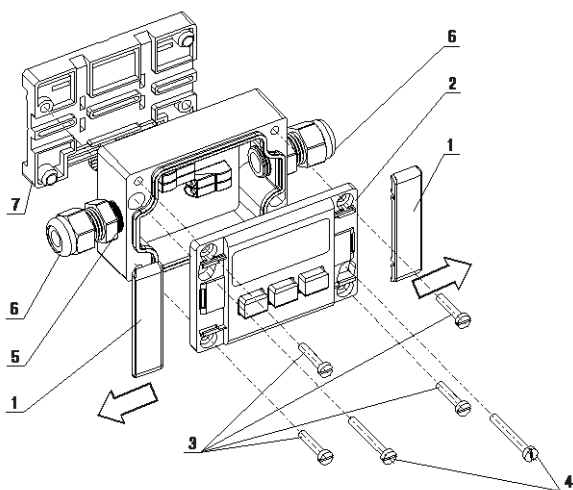

Fig. 2

Installation

1. Remove the slide covers (1) in the direction of the arrows (Fig. 2).
2. Unscrew the screws (3) and remove the front panel (2).
3. Screw the cable glands (included) with the sealing rings (5) tightly into the enclosure, so as to guarantee the IP65 protection.
4. Not used cable entry has to be locked with the blind cap (included).
5. Feed the cable through the cable gland into the enclosure.
6. Connect the wire ends according to the wiring diagrams (Fig. 4 - 6) and tighten the cap nut (6).
7. Put the front panel (2) back and fasten it with the screws (3).

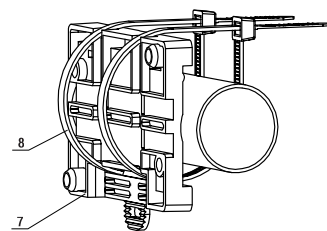

Fig. 3

8. To mount the device on DIN rail attach the carrier (7) to the device using the two screws (4) and snap the device onto the DIN rail.
9. To mount the device on a tube attach the carrier (7) to the tube using two 6 mm wide cable ties (Fig. 3), then attach the device to the carrier (7) using the screws (4).
10. To mount the device on the wall use the two holes for the screws (4)
11. Snap the two slide covers (1) onto the front panel (2).

Wiring diagrams

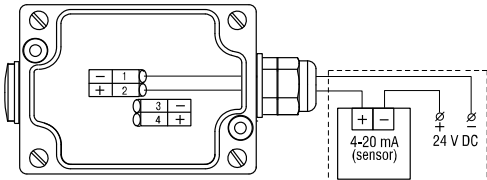

Fig. 4 Connection from the right

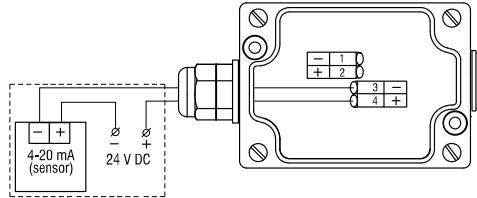

Fig. 5 Connection from the left

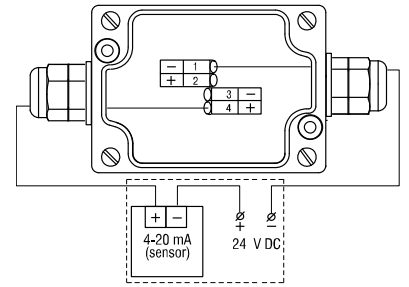

Fig. 6 Two side connection (terminals 1, 4 or 2, 3)

Wire connection

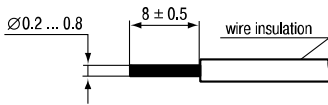

Fig. 7 Wire preparation

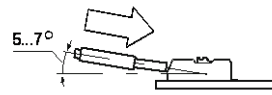

Fig. 8 Connecting the wire to the terminal

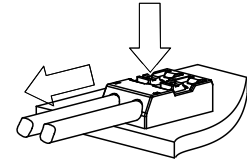

Fig. 9 Disconnecting the wire

Fit the stranded wire with a wire end ferrules

Press the actuation lever and the contact is opened

Programming

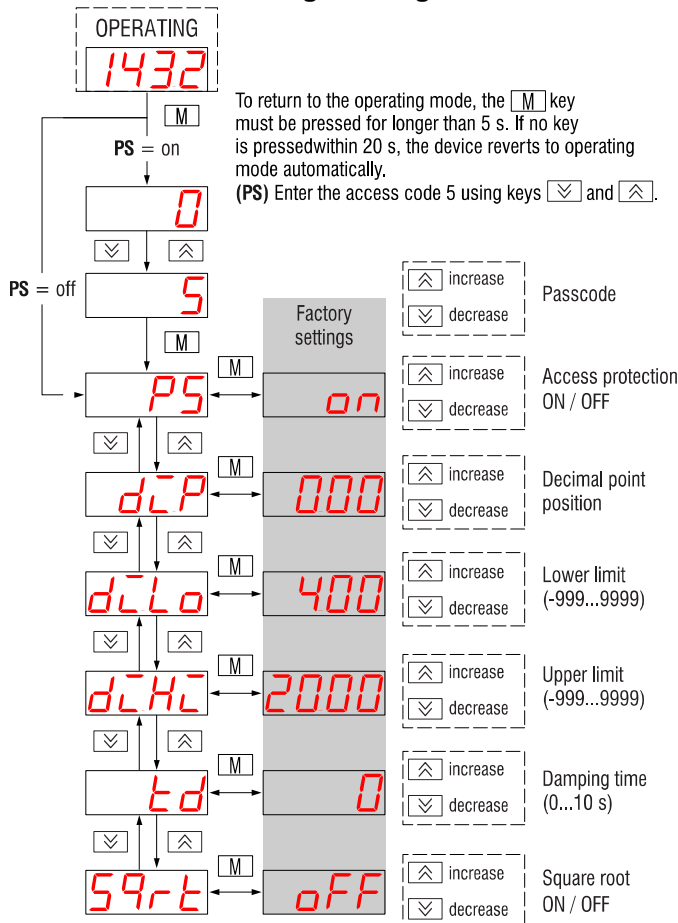

Fig. 10 Flowchart

Operation

Conversion functions

$$\text{linear function} \quad T = di.Lo + \frac{I-4}{16} (di.Hi - di.Lo)$$

$$\text{square root function} \quad T = di.Lo + \sqrt{\frac{I-4}{16}} \cdot (di.Hi - di.Lo)$$

where

T – displayed value corresponding to input signal **I**, mA

di.Lo – Lower limit, corresponds to 4 mA

di.Hi – Upper limit, corresponds to 20 mA

Display messages

Display	Cause
L_0	Input current lower than 3.8 mA
H_0	Input current higher than 22.5 mA
« \bar{L} - - - -»	Upper menu line has been reached
« - - - - \bar{L} »	Lower menu line has been reached
not lit	No input signal Polarity reversal

With particular setting parameters the device cannot actually display the necessary 5 figures due to the restriction to four segments.

Example

The parameters are configured as follows:

di.Lo: -999 → 4 mA

di.Hi: 9999 → 20 mA

With an input measured current of 20.8 mA the correct display should be "10548". Due to the restriction to four segments, the first character is removed and the display is "0548".

Maintenance

The maintenance includes:

- cleaning the housing and the terminals from dust, dirt and debris
- checking the fastening of the device
- checking the wiring (connecting leads, fastenings, mechanical damage)

The device should be cleaned with a damp cloth only. No abrasives or solvent-containing cleaners may be used.